



Module contents

★ **Avaya Wireless versus Avaya Wireless**

★ The ISM Band

★ Sources of interference

★ Methods to coexist

Avaya Wireless versus Avaya Wireless

Terminology - Channel

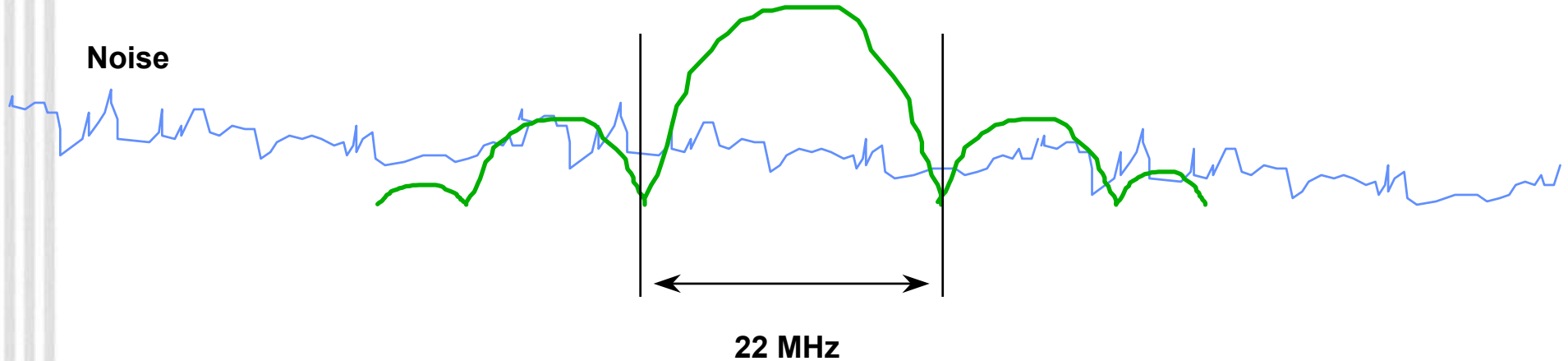

- ★ 22 MHz wide band used for data communication of up 11 Mbit/s
- ★ forward looking error correction through 11x spreading code
- ★ Avaya Wireless Signal level at least 10 dB stronger than Noise level,
e.g. when noise is -80 dBm than required Avaya Wireless signal is -70 dBm



Avaya Wireless versus Avaya Wireless

Terminology - Deferring

- ★ Multiple stations can share the same channel through CSMA/CA
- ★ Avaya Wireless PC Card radio recognizes other Avaya Wireless transmissions in the same band as being a RF modem and will defer (I.e. wait for other stations transmission to be completed)
- ★ Avaya Wireless PC Card only defers for signals that are recognized as “RF modem signal”, not for all detected RF energy
- ★ Deferring manifests implies sharing bandwidth



Avaya Wireless versus Avaya Wireless

Terminology - Interference

- ★ Any form of RF energy sensed by the radio, and that is not recognized as a RF modem signal, is considered “interference”
- ★ Avaya Wireless PC Card radios will not defer for interference
- ★ Interference may lead to loss of packets, and re-transmissions and to a fallback to lower speed
- ★ Interference depends on position of the source of disturbance relative to the receiver
- ★ Interference manifests itself to a user as a reduction in coverage distance and performance

Avaya Wireless versus Avaya Wireless

Multiple channels in the available band

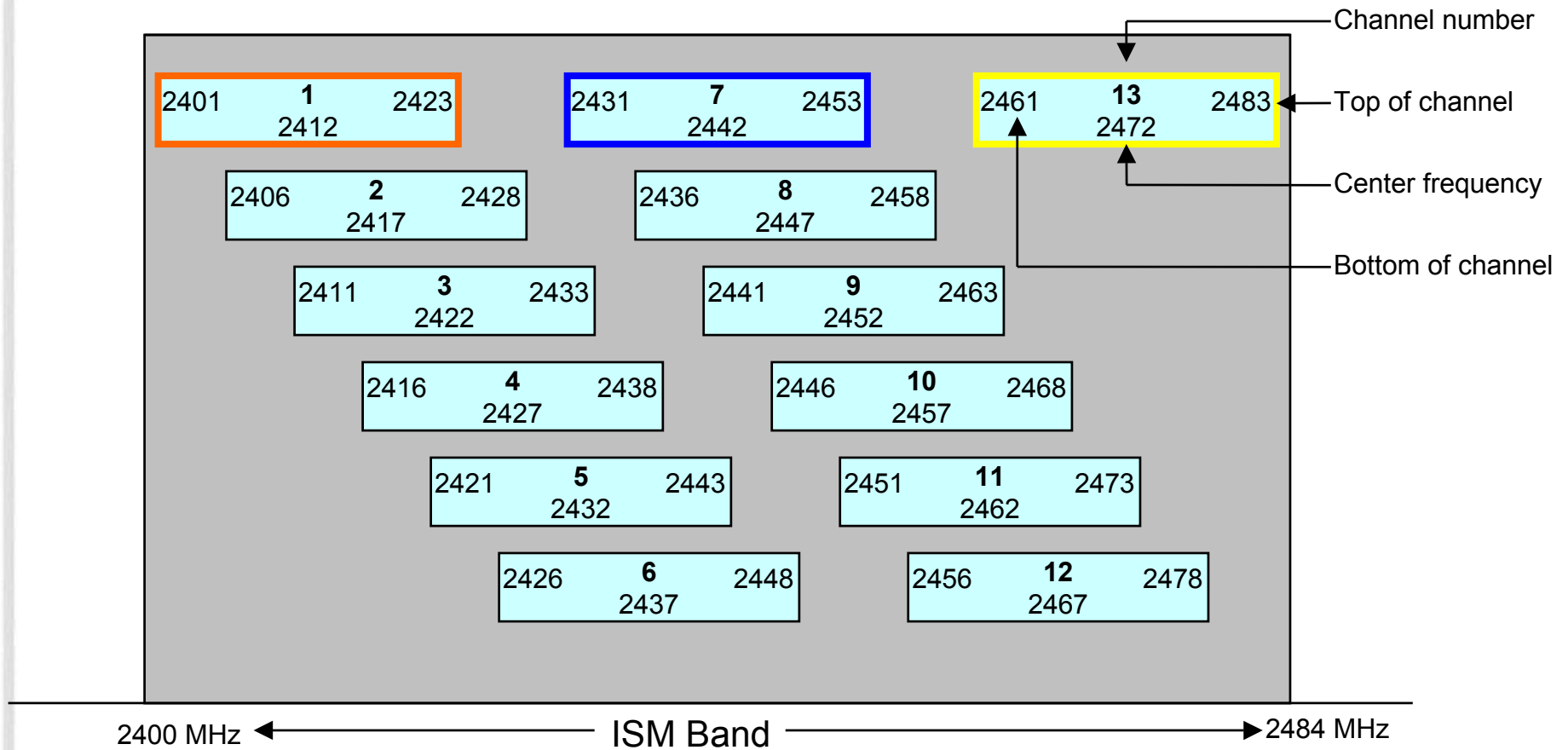

Avaya Wireless versus Avaya

Wireless Terminology - Channel separation

- ★ Distance between the center frequency of channel when multiple channels are used
- ★ Side lobes may overlap:
 - ★ Signal level at 11 MHz from center low enough to be non - interfering with channel at 22 MHz distance (center to center)

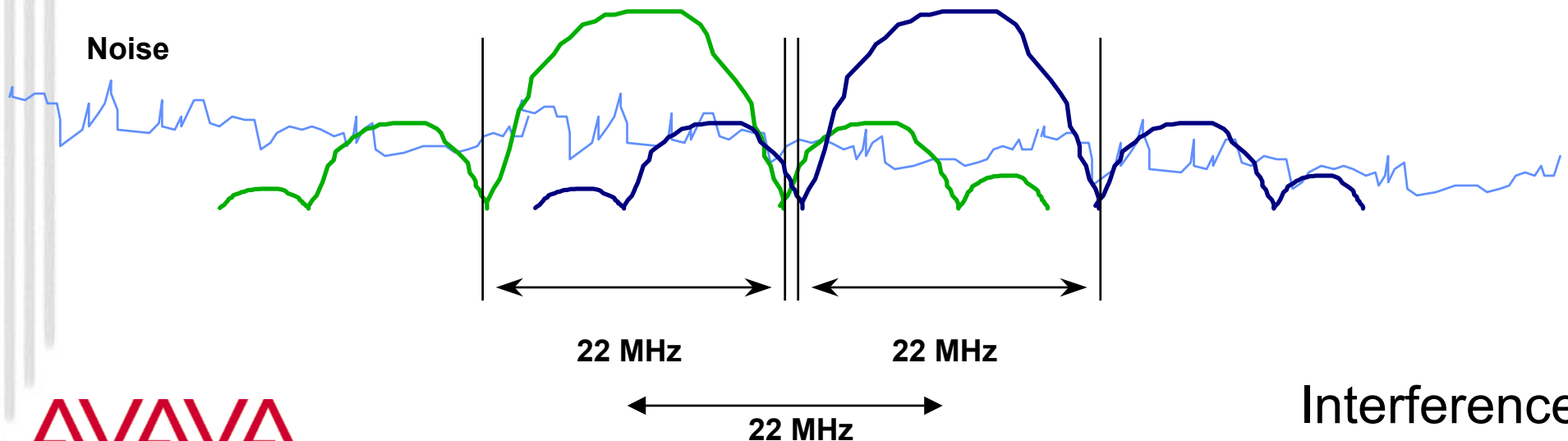

Avaya Wireless versus Avaya Wireless

Terminology - Channel separation

- ★ Insufficient channel separation
- ★ Main lobes also overlap:
 - ★ Signal level at 11 MHz from center will not be strong enough to be sensed due to the signal strength of the other channel
 - ★ One channel senses the other channel's transmission as interference

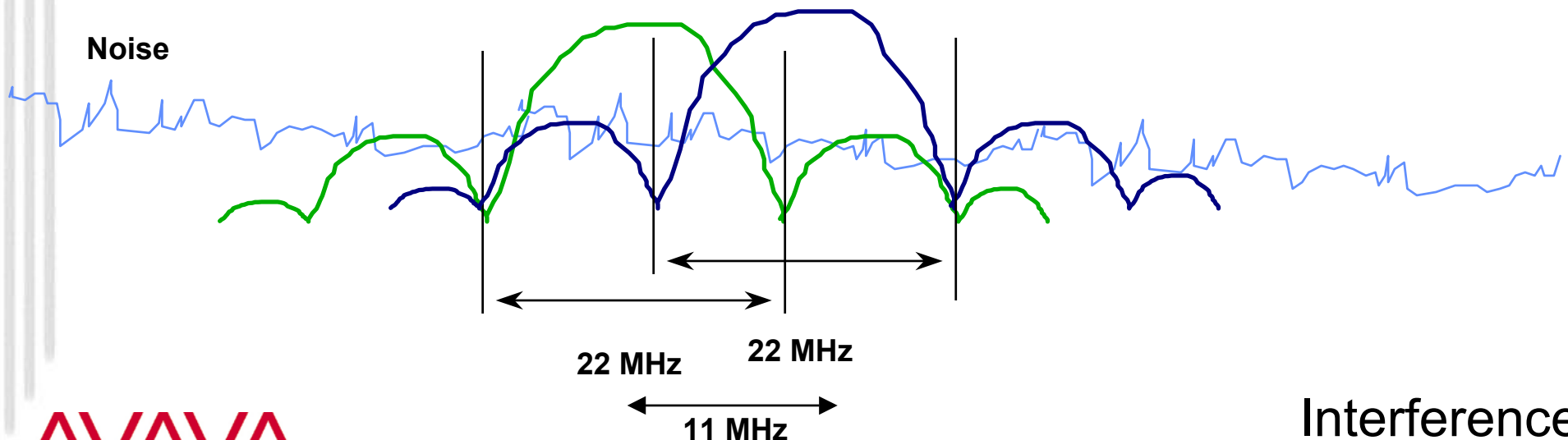



Avaya Wireless versus Avaya Wireless

Terminology - Adjacent Channel Rejection

- ★ Capability of the Avaya Wireless PC Card receiver to recognize the transmission of an adjacent channel as a RF modem signal and filter it as such making the receiving station defer for the signal
- ★ Expressed as delta of strength of the “in-band” signal and the signal received from the adjacent channel (in dB)
 - ★ ACR measured to be 35 dB, meaning: if signal from adjacent channel is 35 dB stronger than the in-band channel, it can be recognized and rejected
- ★ Depends on the channel separation and the physical distance between the receiving station and the transmitting station in the other band (Near-Far Behavior)

Avaya Wireless versus Avaya Wireless

Terminology - Near-Far Behavior

- ★ Impact of physically nearby station that operates in different channel
- ★ Seen as interference - no defer
- ★ Minimum distances need to be observed to allow good operation

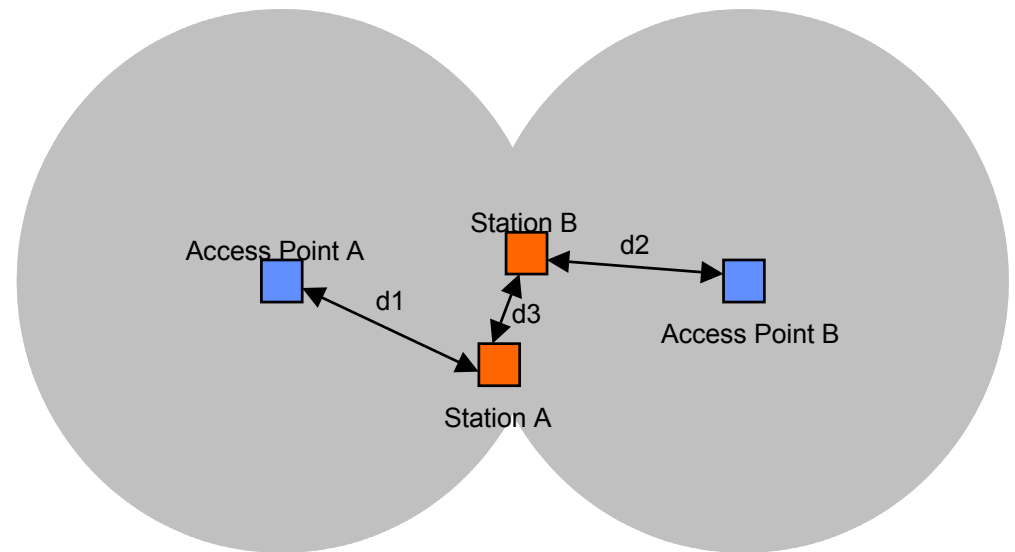

Station-A's channel	Station-B's channel				
Channel 1	Channel 3	Channel 4	Channel 5	Channel 6	Channel 7
Distance d3	5-10 meter	1-4 meter	1-2.5 meter	1-2 meter	1-1.5 meter

$d1 = d2 = 20$ meter



Module contents

★ Avaya Wireless versus Avaya Wireless

★ **The ISM Band**

★ Sources of interference

★ Methods to coexist

The ISM Band

- ★ Dedicated band made available for radio LANs
- ★ Industrial, Scientific and Medical band : 2400 - 2483.5 MHz
- ★ Set aside under ETSI (EMEA), FCC (USA), MKK (Japan)
- ★ Each country endorses band (local type approval)
- ★ Regulatory body can help out in case of “Illegal users”

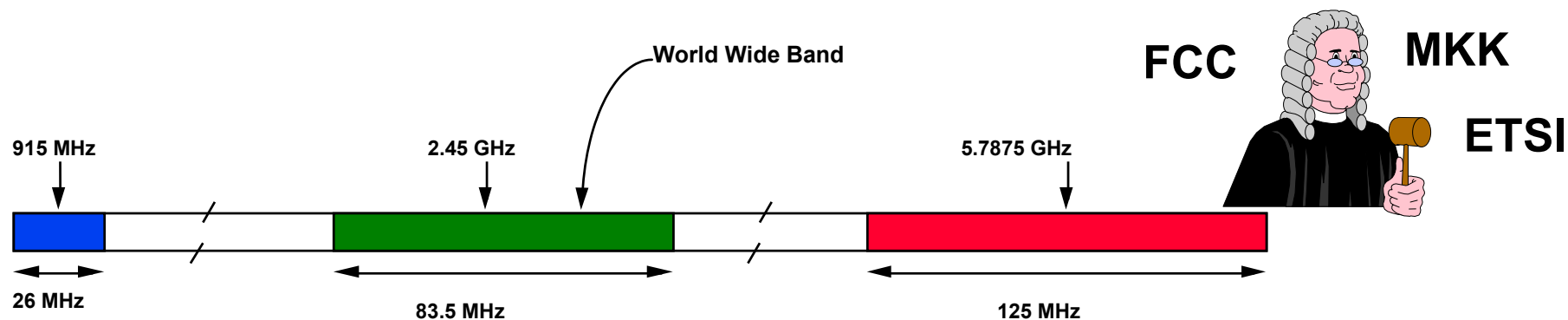

The ISM Band

2400 - 2483.5 MHz ISM Band Mix

Microwave Ovens & other
Industrial, Scientific equipment



1 Watt leakage

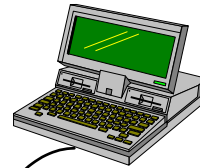

Wireless LANs, WANs
all ISM bands @ 100 mWatt

Government & Military
radio links

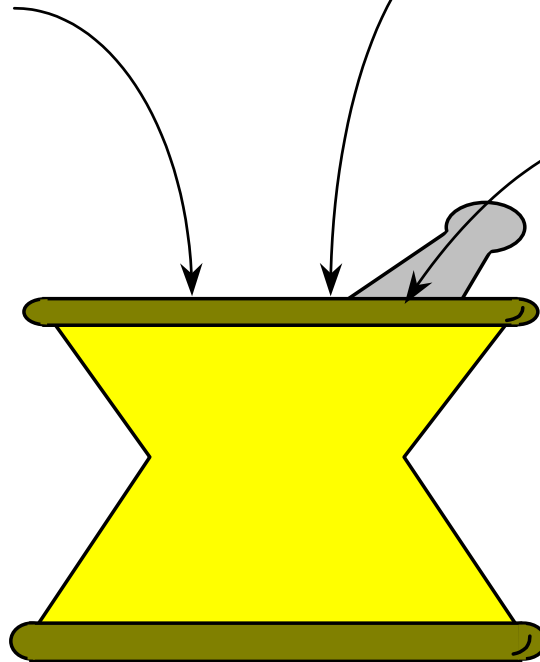



Module contents

- ★ Avaya Wireless versus Avaya Wireless
- ★ The ISM Band
- ★ **Sources of interference**
- ★ Methods to coexist



Sources of interference

- ★ Microwave ovens
- ★ Other wireless systems
- ★ Electrical devices
- ★ Passive systems

Sources of interference

Microwave oven

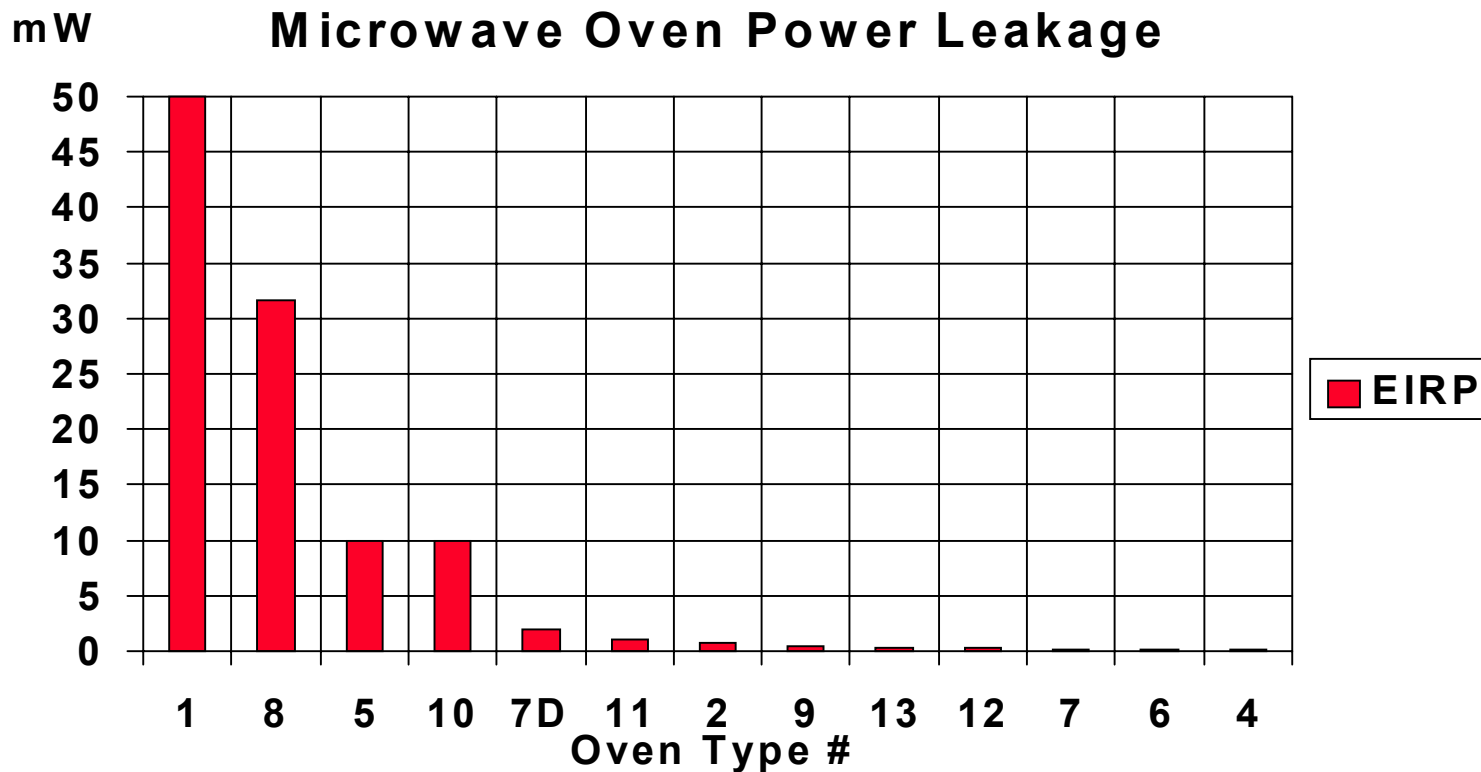

Data from NTIA Report 94-303-1 US department of Commerce

Sources of interference

Microwave oven - example of spectrum used

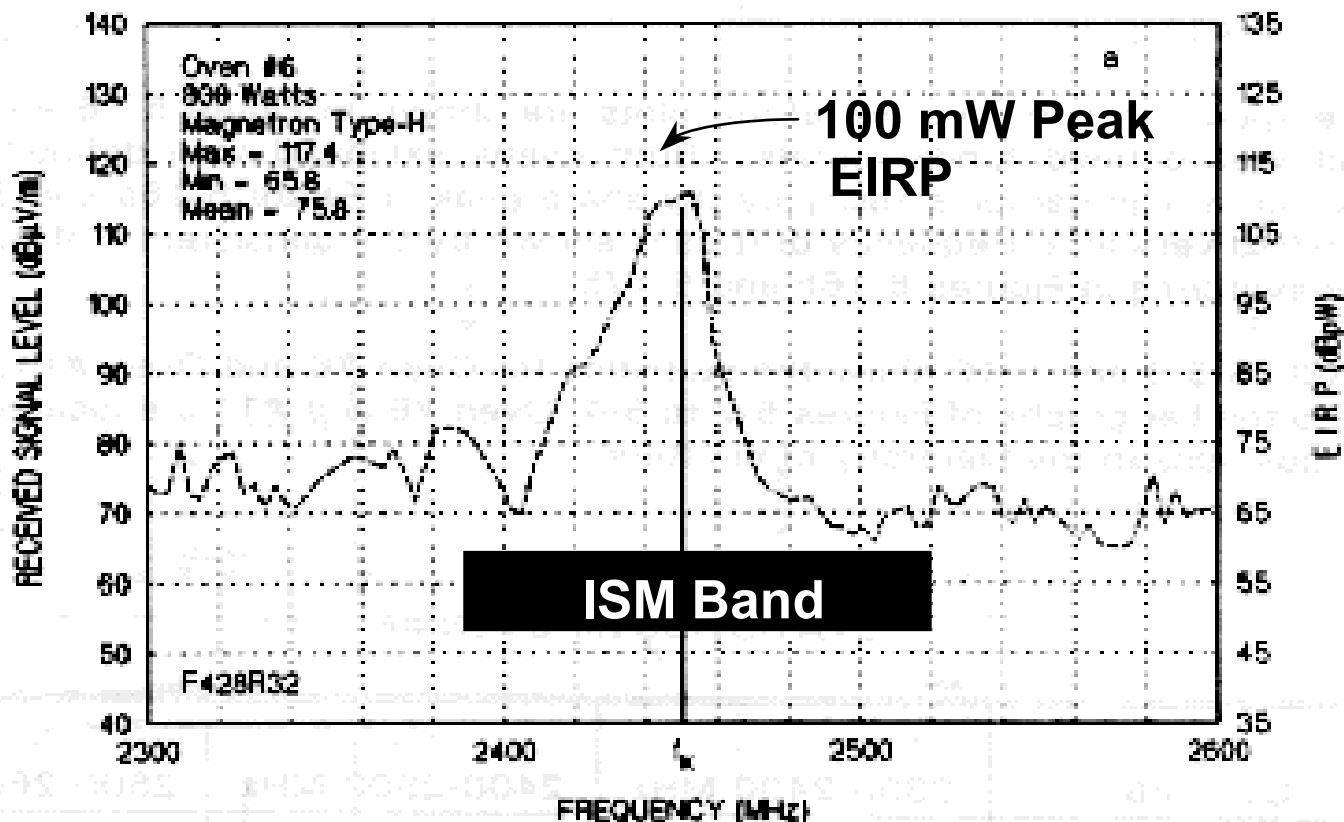

Data from NTIA Report 94-303-1 US department of Commerce

Sources of interference

Microwave oven - operational distances

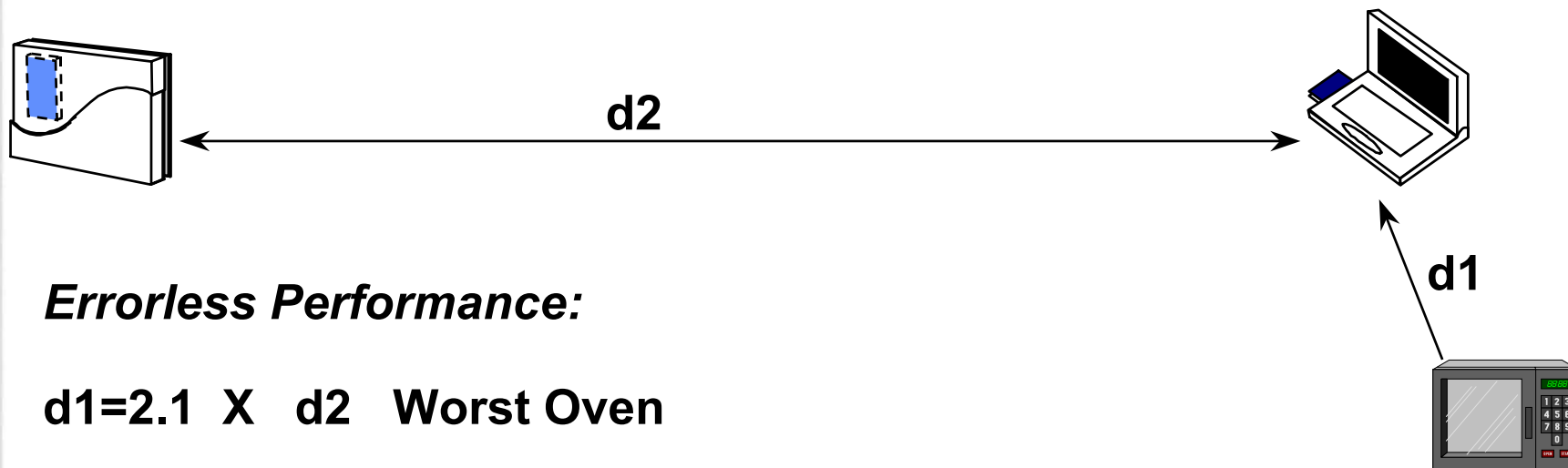

Errorless Performance:

d1=2.1 X d2 Worst Oven

d1= .6 X d2 Average Oven

d1= .35 X d2 Best Case Oven

Sources of interference

Time Domain Emission of Microwave Oven

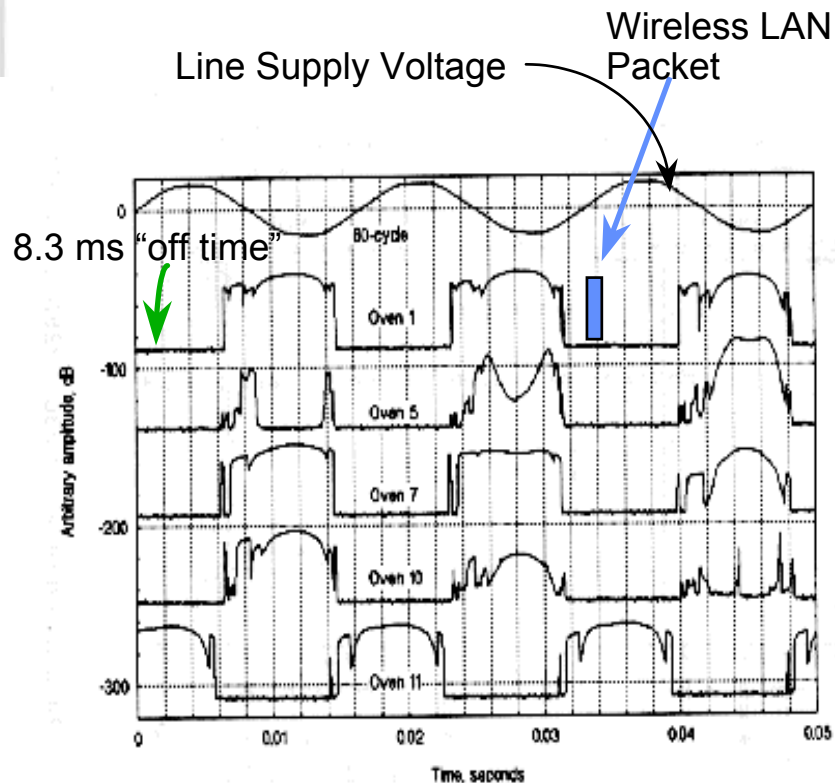

- ★ Microwave oven uses on/off cycle
- ★ Off cycle could be used to get wireless transmissions through
- ★ Depending on the power cycle (50 or 60 Hz), the “off time” equals to 10 or 8.3 msec
- ★ Transmitting a max size packet (1500 bytes) takes app.:

12.5 msec	@1 Mbps
6.2 msec	@2 Mbps
2.3 msec	@5.5 Mbps
1.1 msec	@11 Mbps

Data from NTIA Report 94-303-1 US department of Commerce

Sources of interference

Microwave Oven robustness

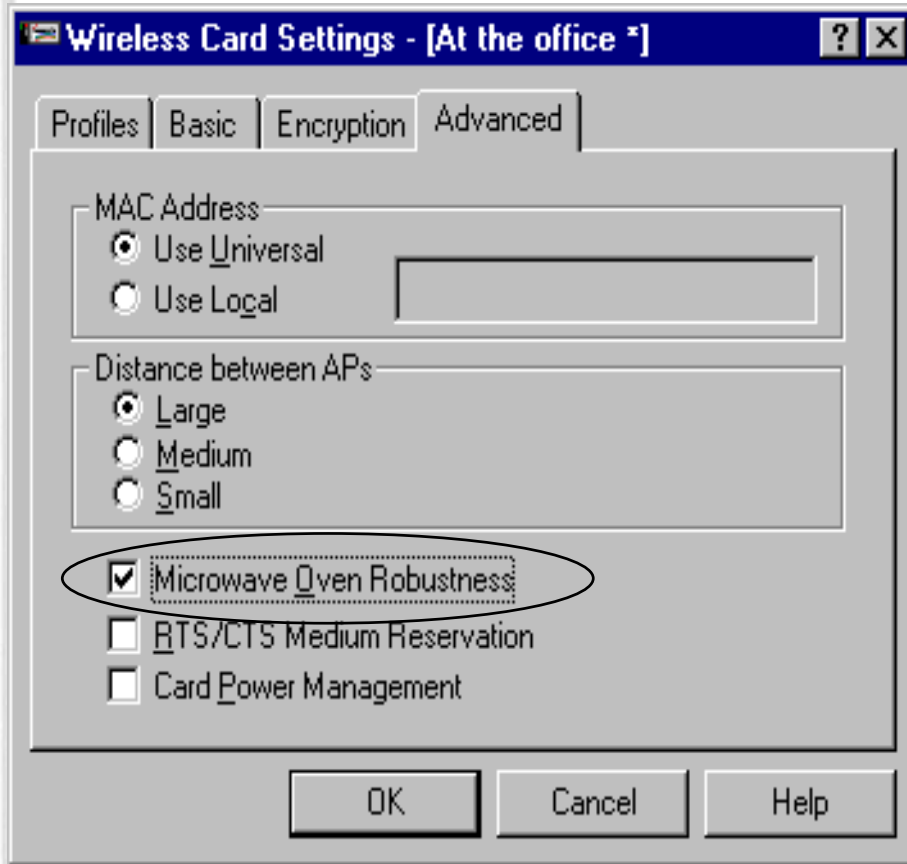

- ★ Under normal operational settings, the Avaya Wireless PC Card will fall back in speed after two successive lost ACKs (which can happen as result of interference)
- ★ If the Microwave Oven is the source of the interference, it would mean that the situation gets worse (lower speed means less chance to hit the off-cycle)
- ★ Selecting “Microwave Oven Robustness” avoids falling back in speed too quickly and never drops to 1 Mbps



Sources of interference

Other wireless systems

★ Other ISM systems

- ★ Wireless LANs (FH and DS) typically use low power if adhere to regulations

★ Other (unknown Avaya Wireless users)

- ★ Office buildings with more than company
- ★ May need coordination between IT staff of Avaya Wireless using companies

★ Non-ISM systems

- ★ High powered devices
- ★ May need arbitration from regulatory authorities



Sources of interference

Electrical devices

★ Indoor:

- ★ Elevator motors
- ★ Overhead cranes with heavy spiking electric motors
- ★ Welding equipment

★ Outdoor elements

- ★ Power lines
- ★ Electrical railroad track
- ★ Power stations



Sources of interference

Passive systems

Passive systems

★ Indoor

- ★ walls that contain metal
- ★ cabinets
- ★ metal desks

★ Outdoor

- ★ Structures, buildings etc
- ★ Moving objects: aircraft, cranes, vehicles



Module contents

- ★ Avaya Wireless versus Avaya Wireless
- ★ The ISM Band
- ★ Sources of interference
- ★ **Methods to coexist**

Methods to coexist

Locate source of interference

- ★ Avaya Wireless Client Manager provides noise level reading
 - ★ Select channel and roam looking for noise spikes:

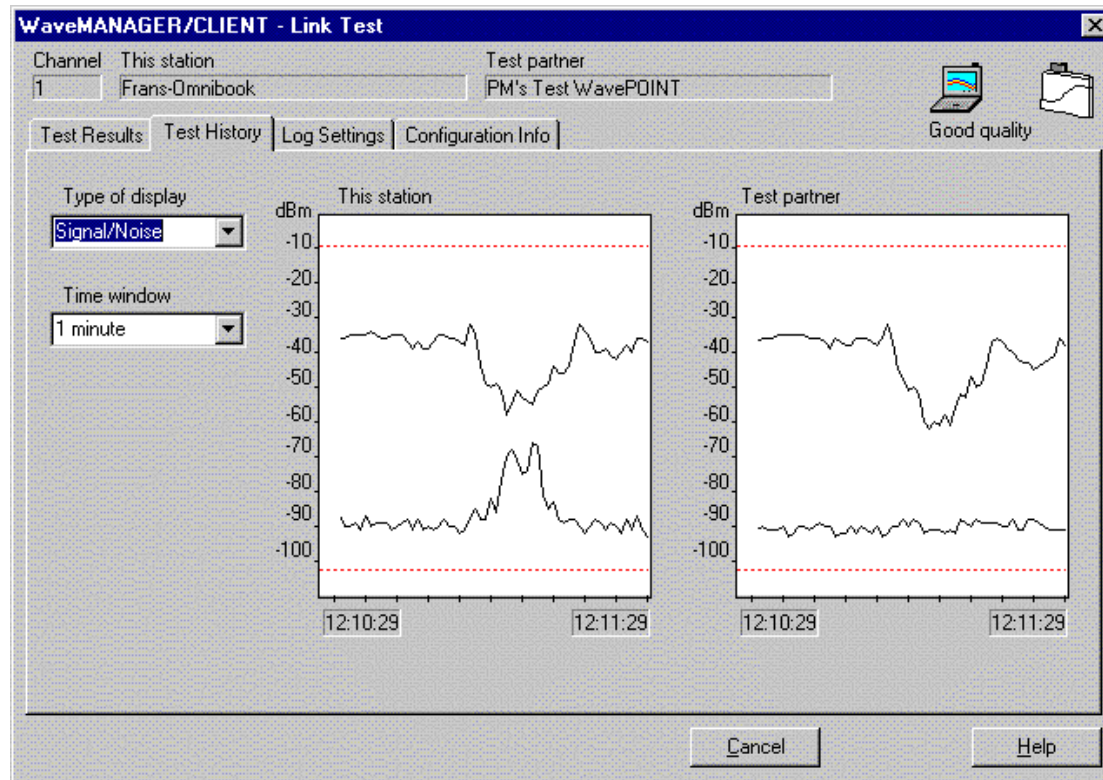



Methods to coexist

Access Point and Station deployment

- ★ Proper site survey to identify potential sources of interference
- ★ Proper positions of the AP-1000 / AP-500 systems as far away from potential sources of interference
- ★ Deploy additional (redundant AP-1000 / AP-500 systems)
- ★ Advice to mobile users to stay clear from sources of interference, when roaming



Methods to coexist

Channel choice

- ★ Based on site analysis choose channels away from frequency used by source of interference
- ★ “Tune around source of interference”



Methods to coexist

Environmental control

- ★ Shield the source of interference
- ★ Change the source of interference (re-tuning to be out of the band)
- ★ Shield the AP-1000 / AP-500 systems to be less effected by source of interference



Methods to coexist

Coexistence of FH and DS

- ★ FH and DS systems experience each other's traffic as noise
- ★ Generally DS systems suffer more from FH systems than vice versa
 - ★ FH systems “hop” around DS systems
 - ★ DS systems establish on a given channel (can only tune around a static source of interference; FH system represent a moving source of interference)
- ★ Interference can be significant depending on
 - ★ respective locations (near/far situations)
 - ★ respective output power levels
 - ★ amount of traffic generated on the FH system
 - ★ the dwell time of the hopper (fast hoppers create less impact than slow ones)
 - ★ Number of co-located FH “channels”

Methods to coexist

Coexistence of FH and DS

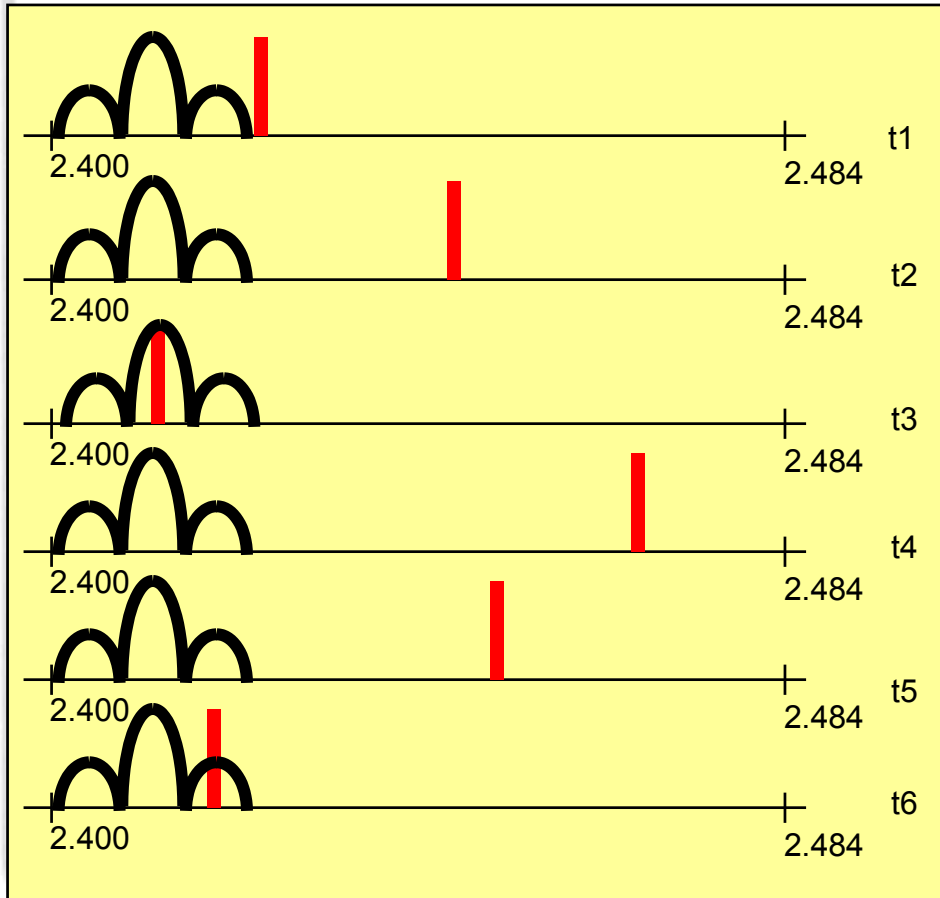

Co-existence of Avaya Wireless LAN and WaveACCESS BR132

- ★ Per 1.6 second, 11 noise spikes can be expected, that may interfere with the channel, based on following parameters:
 - dwell time is 20 msec
 - hop sequence uses 80 frequencies
 - width of the Avaya Wireless frequency channel is 11 MHz
 - there is data traffic between the WaveACCESS LINK BR132 stations
- ★ Spike is narrow (1 MHz)
- ★ Spike lasts for 20 msec



Methods to coexist

Coexistence of FH and DS

Tests have been conducted to assess the impact

- ★ Created WaveACCESS LINK BR132 cell:
- ★ Connect Ethernet station (server) to the BR132 Master
- ★ Connect 2 Ethernet stations (server) to the BR132 Slave
- ★ Establish continued traffic between the stations:
 - ★ Use highest power setting and medium-gain, outdoor Omni-directional antenna
 - ★ Download large files (24 Mbytes) from server to stations (simultaneously)
- ★ Execute Avaya Wireless Client Manager tests from notebook and capture results

Methods to coexist

Coexistence of FH and DS - test set-up

Test set-up

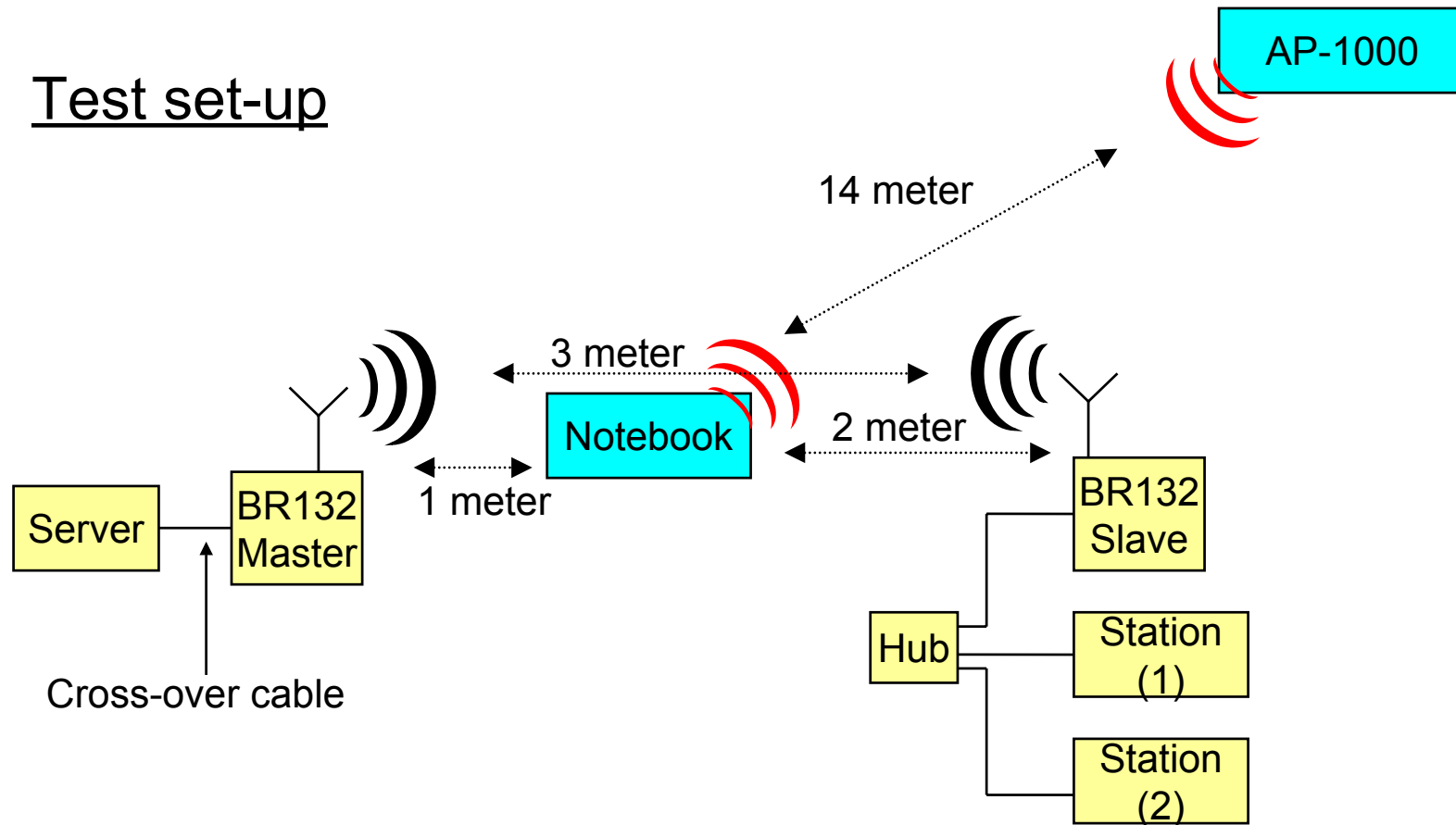

Methods to coexist

Coexistence of FH and DS - test results

Screen capture taken prior to activating the BR132 link

- ★ No spikes are noticed by the notebook station

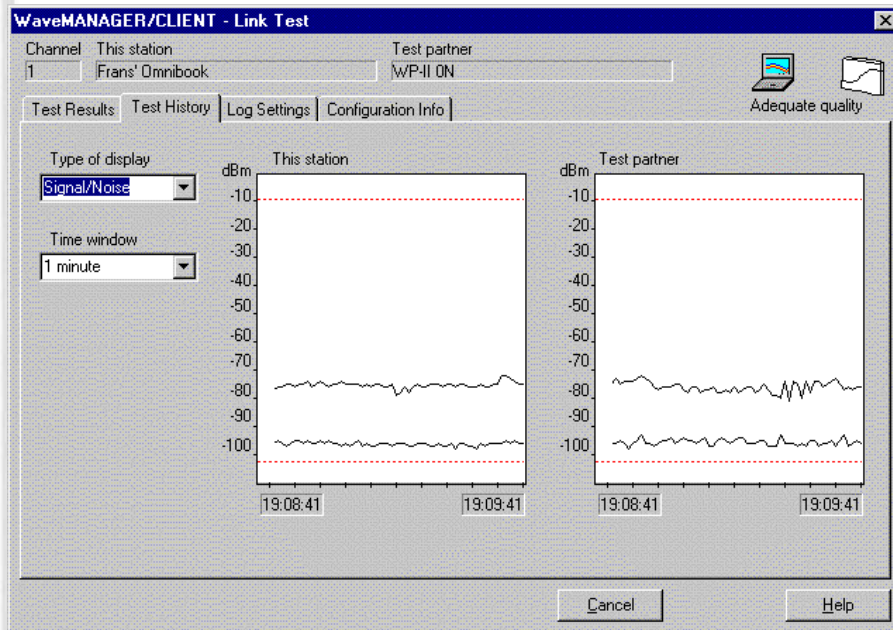

Methods to coexist

Coexistence of FH and DS - test results

Screen capture taken after activating the BR132 link

- ★ Notebook station notices spikes, as result of the file transmission between the stations and the server
- ★ Spikes are not hurting the SNR as there is still enough signal left to communicate, so the Avaya Wireless wireless LAN continues to be operational

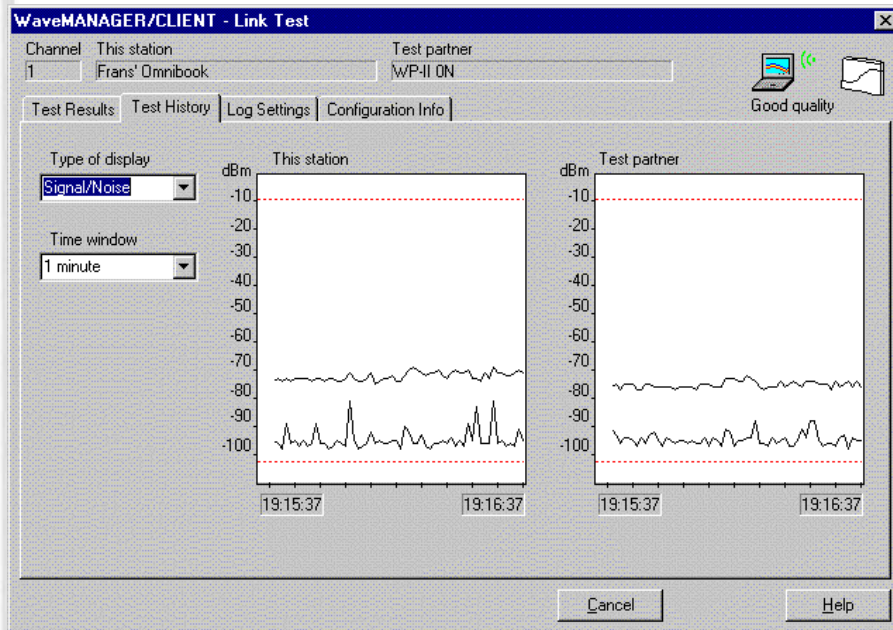

Methods to coexist

Coexistence of FH and DS - test results

Screen capture taken after activating the BR132 link

- ★ No packets are lost as result of the “interfering” transmission.
- ★ The Avaya Wireless PC Card has dropped in speed and is no longer able to run at Turbo speed, but stays operational

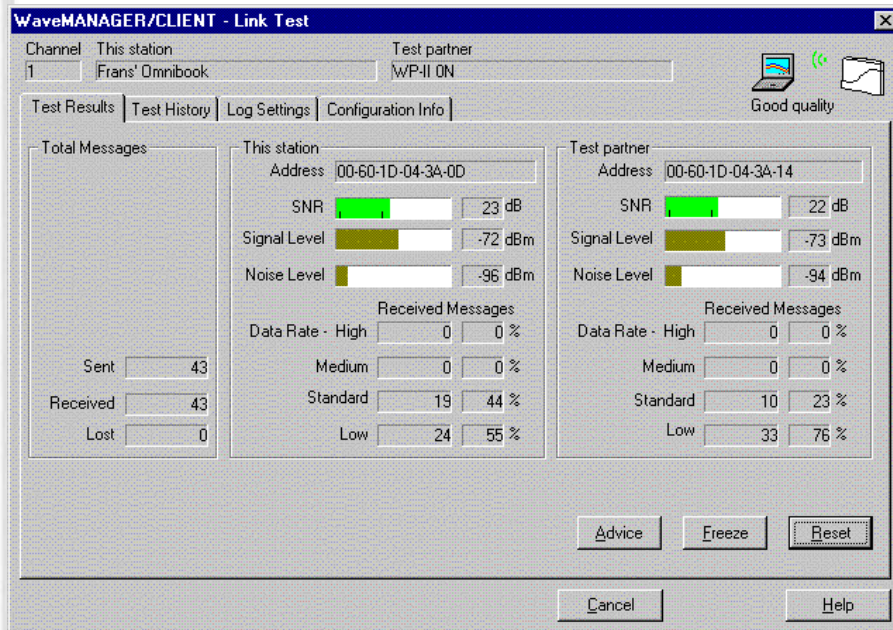



Methods to coexist

Coexistence of FH and DS - conclusion

- ★ WaveACCESS Link BR132 systems will coexist with Avaya Wireless wireless LAN systems, without significant negative impact
- ★ Similar test with WaveACCESS NET have resulted in similar results: co-existence does not seem to present major issues
- ★ In WaveACCESS net systems, interference for Avaya Wireless wireless LAN systems could be compounded when co-located CUs are applied:
 - ★ With each added CU, the number of spike occurrences will be increased with 11
 - ★ Does apply only when CU uses Omni-directional antennae (does not apply when sectored antennae are used)



Module summary

- ★ Avaya Wireless versus Avaya Wireless
- ★ The ISM Band
- ★ Sources of interference
- ★ Methods to coexist